

Features

- Six Proflex® hydromassage jets can be individually adjusted for water flow and direction
- Built-in heater
- Integral lumbar support
- Textured bottom surface
- Multiple pump location options give you more choices for installation and access
- Single-speed whirlpool offers performance and value, with six fully adjustable jets

Material

- KOHLER® enameled cast iron

Installation

- Drop-in or undermount
- Reversible drain

Required Products/Accessories

K-23857 Bath drain trim

or

K-78440 33" cable pop-up bath drain

Recommended Products/Accessories

K-1179 Vinyl Tiling-in Bead
K-586 Under-Mount Installation Kit
K-1172 Adjustable feet
K-1491 Bath/Whirlpool Pillow
K-1601 Bath/whirlpool footstop, removable
K-23726 Drain treatment
K-23725 Cast iron cleaner
1015255 Jet trim kit



ADA

Codes/Standards





ASME A112.19.7/CSA B45.10
ASME A112.19.1/CSA B45.2
ASTM F462
UL 1795
CSA C22.2 No. 218.2
ADA
ICC/ANSI A117.1
cUL Listed
UL Listed

**KOHLER® Hydrotherapy
Components Five-Year Limited
Warranty KOHLER® Enameled Cast
Iron Bath and Shower Base Lifetime
Limited Warranty**

See website for detailed warranty information.

Available Colors/Finishes

Color tiles intended for reference only.

Color	Code	Description
	0	White
	96	Biscuit
	NY	Dune
	7	Black Black™

No change in measurements if connected with drain illustrated. (K-23856-NA)

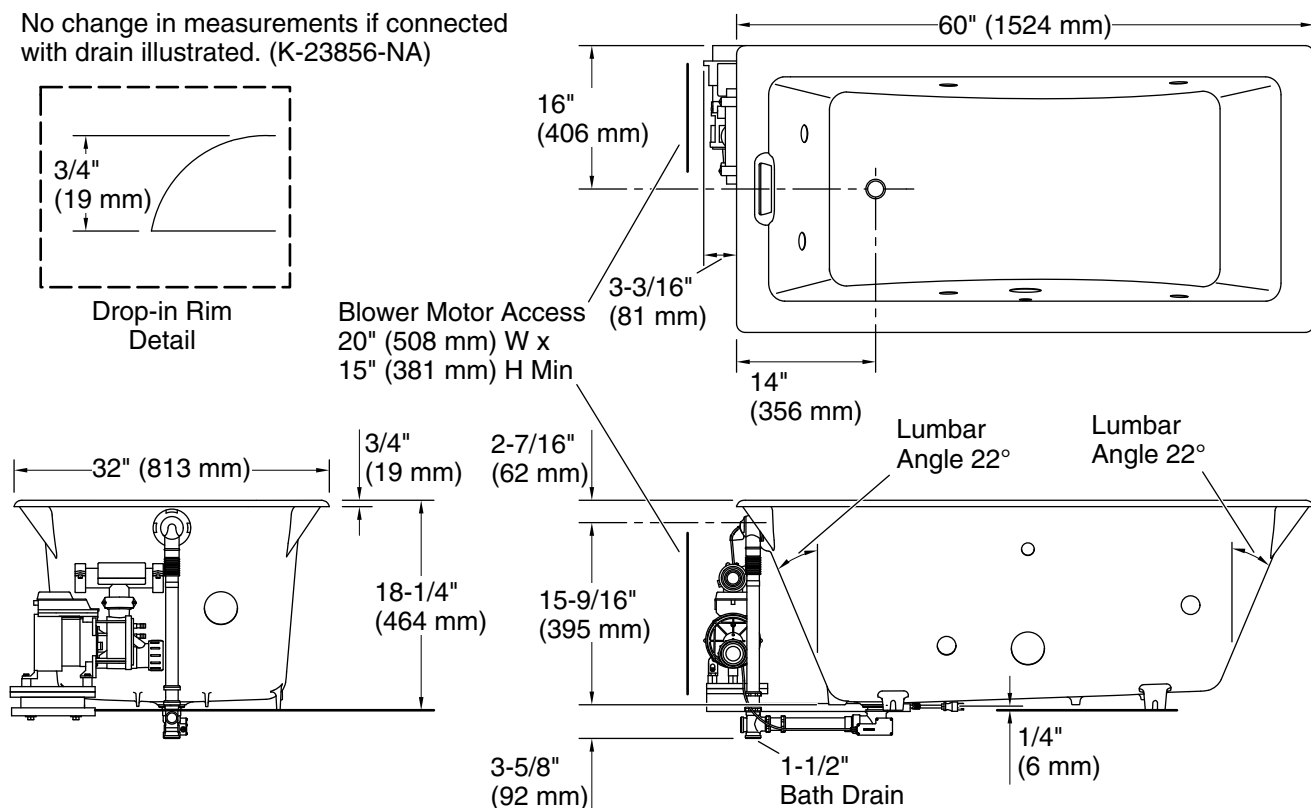

Required Electrical Service

Two dedicated circuits required, protected with Class A Ground-Fault Circuit-Interrupter (GFCI). Outside North America, this device may be known as a Residual Current Device (RCD).

Pump: 120 V, 15 A, 60 Hz
Heater: 120 V, 15 A, 60 Hz

Technical Information

All product dimensions are nominal.

Drain location: Reversible
Basin area, bottom: 40-1/2" x 20" (1029 mm x 508 mm)
Basin area, top: 52-3/4" x 24" (1340 mm x 610 mm)
Weight: 290 lbs (131.5 kg)
Minimum floor load: 60 lbs/ft² (292.9 kg/m²)
Water depth: 13-5/8" (346 mm)
Water capacity: 60 gal (227.1 L)
Cutout: Drop-in, 58-1/2" x 30-1/2" (1486 mm x 775 mm)
Electrical component rating: Pump: 120 V, 7 A, 60 Hz
Heater: 120 V, 12 A, 60 Hz

Pump speed: Single

1-800-4KOHLER (1-800-456-4537)

Kohler Co. reserves the right to make revisions without notice to product specifications.

For the most current Specification Sheet, go to www.kohler.com USA or www.kohler.ca Canada

9-20-2025 15:05 - US/CA

Notes

Measure your actual product for rough-in details.

Install this product according to the installation instructions.

The hot water supply should be 70% of the capacity of the bath or greater. Installations will vary.

ADA compliant when installed to the specific requirements of these regulations.