



NO-LEAD METER SETTERS & ACCESSORIES



CAMBRIDGE BRASS INC.

140 Orion Place, Cambridge, Ontario, N1R 5V1, Canada
www.cambridgebrass.com

© 2009 Cambridge Brass Inc. OCTOBER 2012 CAMB2012



NO-LEAD METER SETTERS & ACCESSORIES

TABLE OF CONTENTS

Part Number Build Sheet	2
Product & Part Numbers	
METER RESETTERS	3
6010NL Meter Resetters	
6011NL, 6012NL, 6013NL Low Rise Resetter	
METER SETTERS	5
6020NL Meter Setters (Horizontal Inlet and Outlet)	
6030NL, 6031NL, 6032NL 6034 NL Straight Line Setters	
6035NL Straight Line Setters (Vertical Inlet/Horizontal Outlet)	
6040NL Vertical Meter Setters (Vertical Inlet and Outlet)	
6050NL Pit Setters (Plastic Pit Not Included)	
6060NL, 6065NL Line Setters	
7010NL, 7011NL Cellar Setters	
7020NL, 7025NL Corner Setters	
Accessories	13

*For additional information, please contact your customer service representative at
Cambridge Brass.*

*Phone: (800)-265-6638 (CDN) * (800) 724-3906 (US) * www.cambridgebrass.com*

NO-LEAD METER SETTERS & ACCESSORIES

METER SETTER PART NUMBERING

EXAMPLE:

6020 NL - 2 07 H 3 H 3 - VQ

SERIES NUMBER	METER SIZE	SETTER HEIGHT	INLET CONNECTION	INLET SIZE	OUTLET CONNECTION	OUTLET SIZE	INLET OPTION	OUTLET OPTION	BY-PASS
---------------	------------	---------------	------------------	------------	-------------------	-------------	--------------	---------------	---------

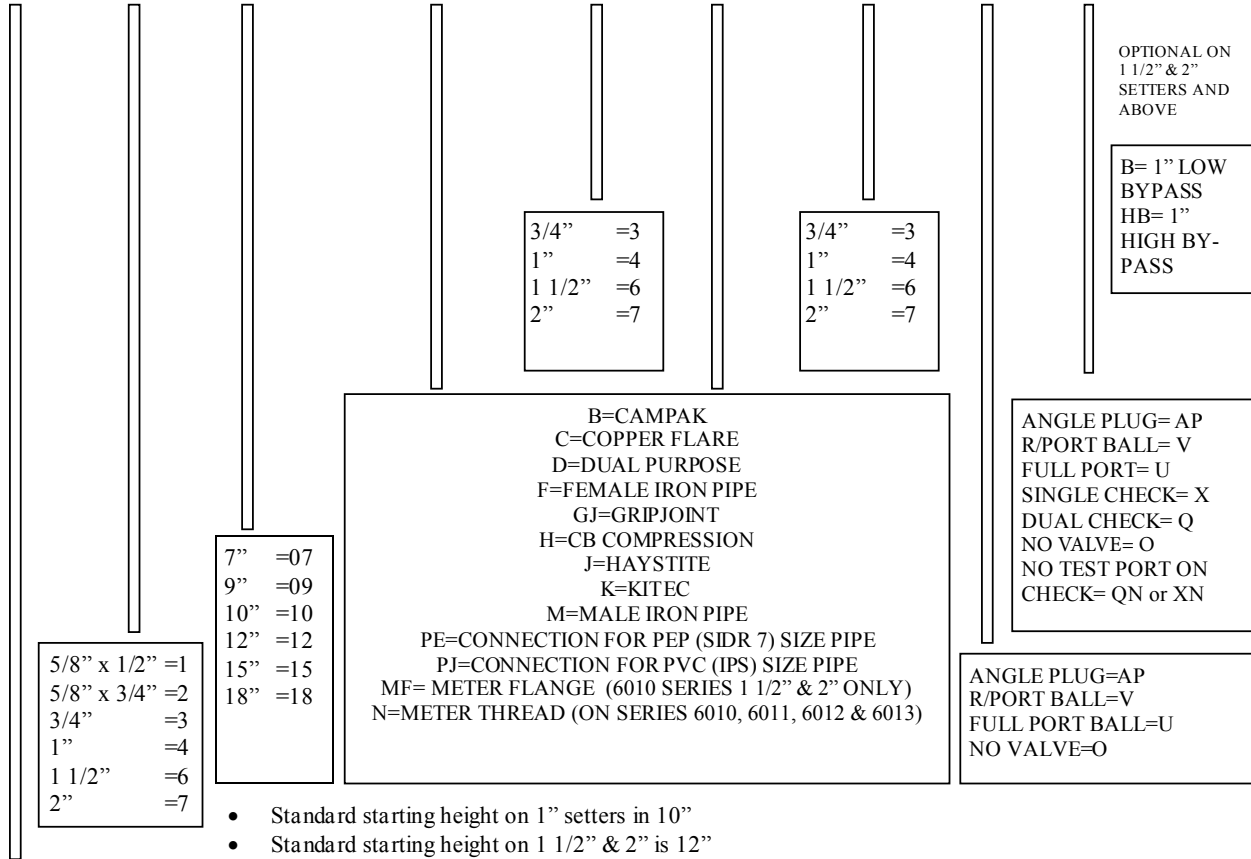

- 6010NL-RESETTER
- 6011NL-LOW RISE RESETTER
- 6012NL-LOW RISE RESETTER (60 DEGREE)
- 6013NL-LOW RISE RESETTER (45 DEGREE)
- 6020NL-METER SETTER (Horizontal Inlet & Outlet)
- 6022NL-METER SETTER (Vertical Inlet & Horizontal Outlet)
- 6029NL-SINGLE YOKE SETTER
- 6030NL-STRAIGHT LINE SETTER (Horizontal Inlet & Outlet)
- 6031NL-STRAIGHT LINE SETTER (Horizontal Inlet & Outlet with 15" Leg Extension)
- 6032NL-STRAIGHT LINE SETTER (Horizontal Inlet & Outlet with 18" Leg Extension)
- 6034NL-STRAIGHT LINE SETTER (Vertical Inlet & Outlet)
- 6035NL-STRAIGHT LINE SETTER (Horizontal Inlet & Vertical Outlet)
- 6040NL-METER SETTER (Vertical Inlet & Outlet)
- 6050NL-BRASS PIT SETTER (Horizontal Inlet & Outlet) inside pit diameter 18"
- 6051NL-BRASS PIT SETTER (Horizontal Inlet & Outlet) inside pit diameter 21 1/4"
- 6052NL-BRASS PIT SETTER (Horizontal Inlet & Outlet) inside pit diameter 16 1/2"
- 6060NL-LINE SETTERS (Horizontal Inlet & Outlet)
- 6065NL-LINE SETTERS (Angle Inlet & Horizontal Outlet)

NO-LEAD METER SETTERS & ACCESSORIES

6010NL METER RESETTERS

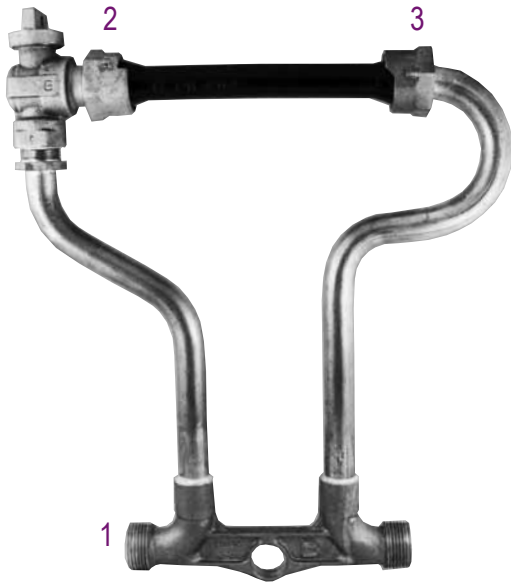

6010NL-212N2N2-VO
Plastic Idler bar included

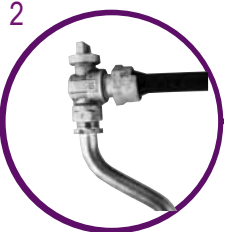
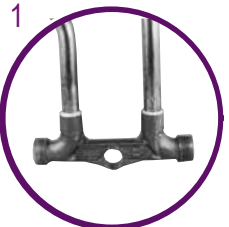

RESETTER SIZE	CODE
5/8" Meter	1
5/8" x 3/4" Meter	2
3/4" Meter	3
1" Meter	4
1 1/2" Meter	6
2" Meter	7

HEIGHT (Centerline to Centerline)
7", 9", 12" and up (in 3" increments) heights above 18" come with a tie-bar

END CONNECTIONS	CODE
5/8" Meter Thread	N1
5/8" x 3/4" Meter Thread	N2
1" Meter Thread	N4
Meter Flange	MF
1 1/2" and 2" Setters	

INLET Options	CODE
No Valve	O
Key Angle Valve	AP
Reduced Port Valve	V
Full Port Valve	U

OUTLET Options	CODE
No Valve	O
Key Angle Valve	AP
Single Check	X
Single Check No Test Port	XN
Dual Check	Q
Dual Check No Test Port	QN
Reduced Port Ball Valve	V
Full Port Outlet	U

Optional on 1 1/2" & 2"	
By-pass	B
High By-pass	HB

For proper part number please reference the Meter Setter part number build sheet on page 2

NO-LEAD METER SETTERS & ACCESSORIES

LOW RISE RESETTER

6011NL - 90° Angle, 6012NL - 60° Angle & 6013NL 45° Angle

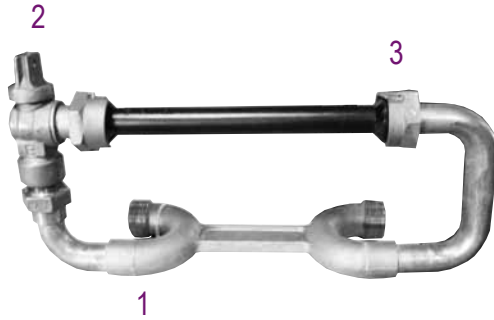

6011NL-2N2N2-VO
Plastic Idler bar included

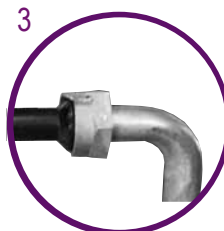
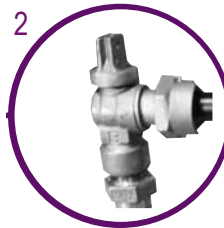
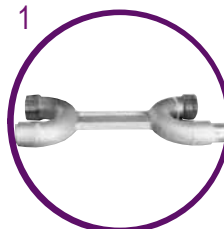
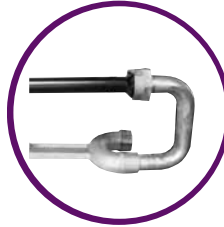
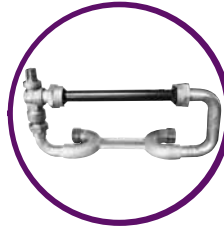

SETTER SIZE	CODE
5/8" Meter	1
5/8" x 3/4" Meter	2
3/4" Meter	3
1" Meter	4

HEIGHT (Centerline to Centerline)
3.8" for 5/8", 5/8" x 3/4", 3/4"
5.3" for 1"

INLET/OUTLET SIZE	CODE
5/8" Meter Thread	N1
5/8" x 3/4" Meter Thread	N2
1" Meter Thread	N4

INLET Options	CODE
No Valve	O
Key Angle Valve	AP
Reduced Port Valve	V
Full Port Valve	U

OUTLET Options	CODE
No Valve	O
Key Angle Valve	AP
Single Check	X
Single Check No Test Port	XN
Dual Check	Q
Dual Check No Test Port	QN
Reduced Port Ball Valve	V
Full Port Outlet	U

For proper part number please reference the Meter Setter part number build sheet on page 2

NO-LEAD METER SETTERS & ACCESSORIES

6020NL METER SETTERS (Horizontal Inlet and Outlet)

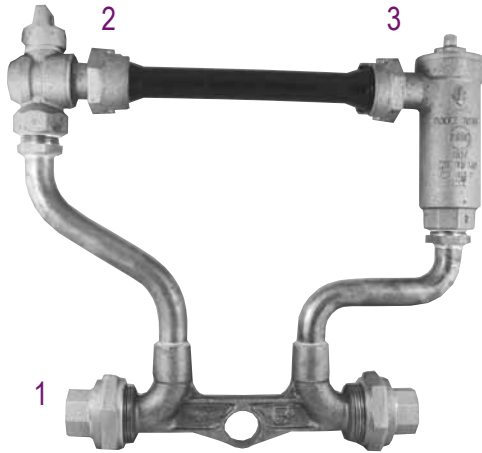

6020NL-209D3D3-VQ
Plastic Idler bar included

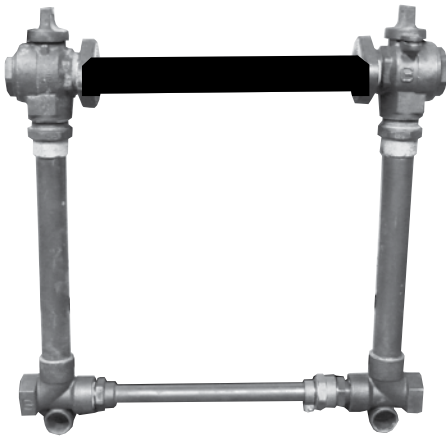

6020NL-618F6F6-UU
Support bar included

Optional on 1 1/2" & 2"	
By-pass	B
High By-pass	HB

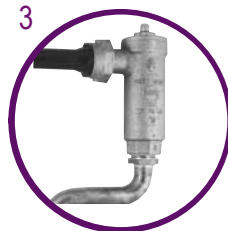
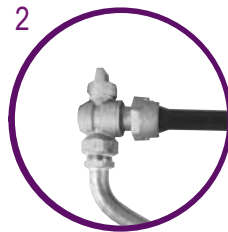
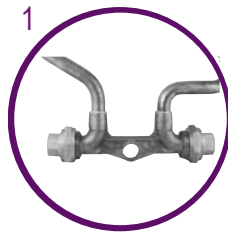
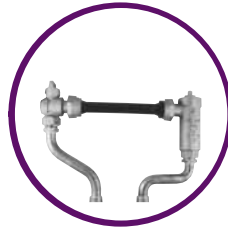

SETTER SIZE	CODE
5/8" Meter	1
5/8" x 3/4" Meter	2
3/4" Meter	3
1" Meter	4
1 1/2" Meter	6
2" Meter	7

HEIGHT (Centerline to Centerline)
7", 9", 12" and up (in 3" increments) heights above 18" come with a tie-bar

END CONNECTIONS	CODE
Dual Purpose	D
CB Compression	H
Campak	B
Gripjoint	GJ
Haystite	J
Kitec	K
FIP	F
MIP	M
PEP (SIDR 7)	PE
PVC (IPS)	PJ
Copper Flare	C
Meter Flange 1 1/2" and 2" Setters	MF

INLET Options	CODE
No Valve	O
Key Angle Valve	AP
Reduced Port Valve	V
Full Port Valve	U

OUTLET Options	CODE
No Valve	O
Key Angle Valve	AP
Single Check	X
Single Check No Test Port	XN
Dual Check	Q
Dual Check No Test Port	QN
Reduced Port Ball Valve	V
Full Port Outlet	U

For proper part number please reference the Meter Setter part number build sheet on page 2

NO-LEAD METER SETTERS & ACCESSORIES

6030NL, 6031NL, 6032NL & 6034NL STRAIGHT LINE SETTERS

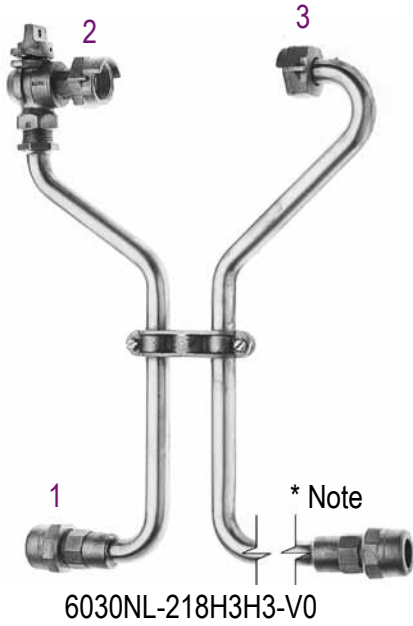

6030NL-218H3H3-V0

*** Note**

- 15" Extension - Series 6031NL
- 18" Extension - Series 6032NL
- 24" Extension - Series 6034NL
- Other extension length available, please contact factory
- Plastic Idler bar included, not shown

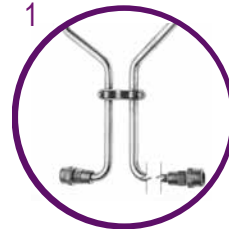
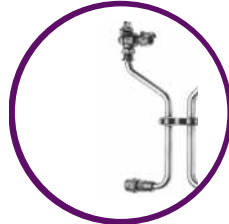
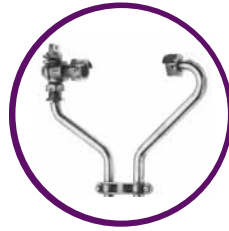

SETTER SIZE	CODE
5/8" Meter	1
5/8" x 3/4" Meter	2
3/4" Meter	3
1" Meter	4

HEIGHT (Centerline to Centerline)
15", 18", 21" and up (in 3" increments)
All setters come with a tie-bar

END CONNECTIONS	CODE
Dual Purpose	D
CB Compression	H
Campak	B
Gripjoint	GJ
Haystite	J
Kitec	K
FIP	F
MIP	M
PEP (SIDR 7)	PE
PVC (IPS)	PJ
Copper Flare	C



6031NL-218H3H3-VX
Plastic Idler bar included, not shown

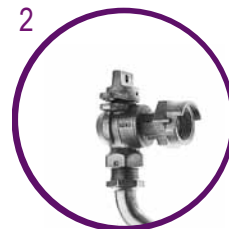

INLET Options	CODE
No Valve	O
Key Angle Valve	AP
Reduced Port Valve	V
Full Port Valve	U

OUTLET Options	CODE
No Valve	O
Key Angle Valve	AP
Single Check	X
Single Check No Test Port	XN
Dual Check	Q
Dual Check No Test Port	QN
Reduced Port Ball Valve	V
Full Port Outlet	U

For proper part number please reference the Meter Setter part number build sheet on page 2

NO-LEAD METER SETTERS & ACCESSORIES

6035NL STRAIGHT LINE SETTERS (Vertical Inlet/Horizontal Outlet)

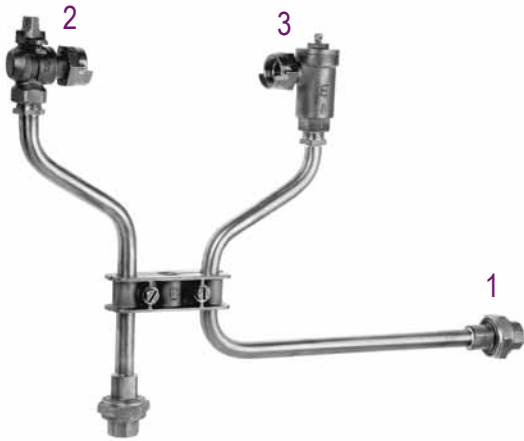

6035NL-215D3D3-VX
Plastic Idler bar included, not shown

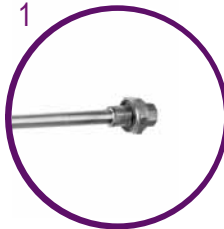
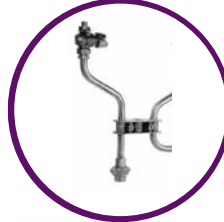
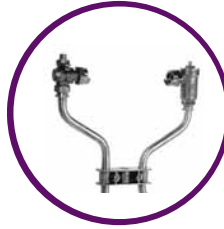

SETTER SIZE	CODE
5/8" Meter	1
5/8" x 3/4" Meter	2
3/4" Meter	3
1" Meter	4

HEIGHT (Centerline to Centerline)
15", 18", 21" and up (in 3" increments)
All setters come with a tie-bar

END CONNECTIONS	CODE
Dual Purpose	D
CB Compression	H
Campak	B
Gripjoint	GJ
Haystite	J
Kitec	K
FIP	F
MIP	M
PEP (SIDR 7)	PE
PVC (IPS)	PJ
Copper Flare	C

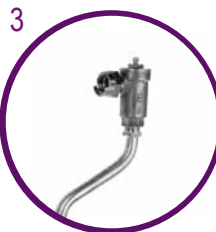
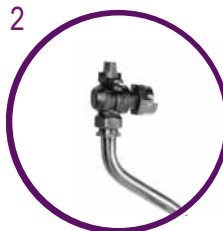

INLET Options	CODE
No Valve	O
Key Angle Valve	AP
Reduced Port Valve	V
Full Port Valve	U

OUTLET Options	CODE
No Valve	O
Key Angle Valve	AP
Single Check	X
Single Check No Test Port	XN
Dual Check	Q
Dual Check No Test Port	QN
Reduced Port Ball Valve	V
Full Port Outlet	U

For proper part number please reference the Meter Setter part number build sheet on page 2

NO-LEAD METER SETTERS & ACCESSORIES

6040NL VERTICAL METER SETTERS (Vertical Inlet and Outlet)

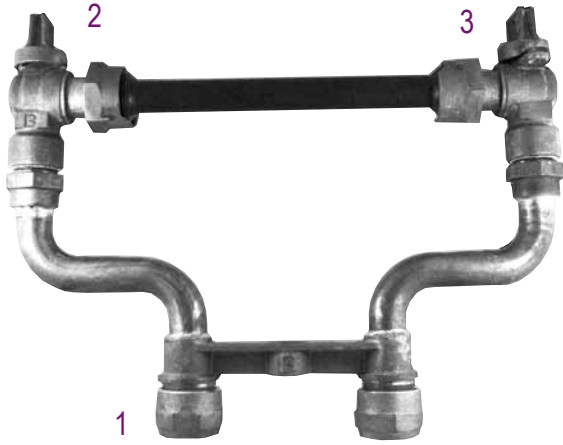

6040NL-207H3H3-VV
Plastic Idler bar included

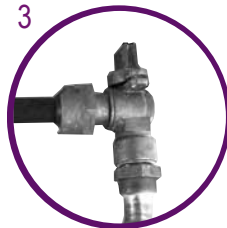
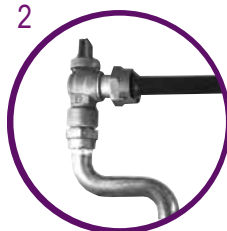
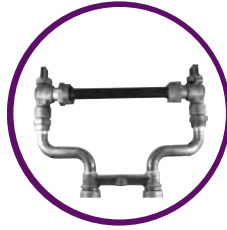

SETTER SIZE	CODE
5/8" Meter	1
5/8" x 3/4" Meter	2
3/4" Meter	3
1" Meter	4

HEIGHT (Centerline to Centerline)

7", 9", 12" and up (in 3" increments)
heights above 18" come with a tie-bar

END CONNECTIONS	CODE
CB Compression	H
Campak	B
Gripjoint	GJ
Haystite	J
Kitec	K
FIP	F
MIP	M
PEP (SIDR 7)	PE
PVC IPS	PJ
Copper Flare	C

INLET Options	CODE
No Valve	O
Key Angle Valve	AP
Reduced Port Valve	V
Full Port Valve	U

OUTLET Options	CODE
No Valve	O
Key Angle Valve	AP
Single Check	X
Single Check No Test Port	XN
Dual Check	Q
Dual Check No Test Port	QN
Reduced Port Ball Valve	V
Full Port Outlet	U

For proper part number please reference the Meter Setter part number build sheet on page 2

NO-LEAD METER SETTERS & ACCESSORIES

6050NL PIT SETTERS (Plastic Pit Not Included)

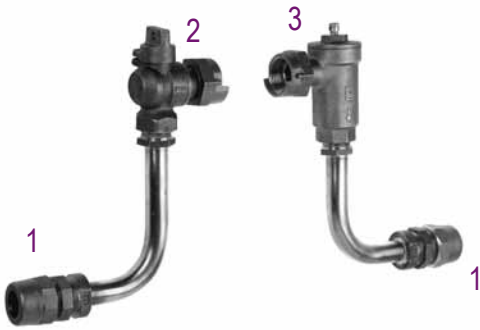

6050NL-207H3H3-VX
Plastic Idler bar included, not shown

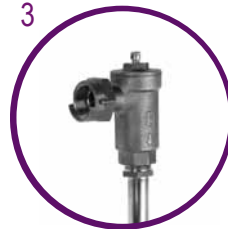
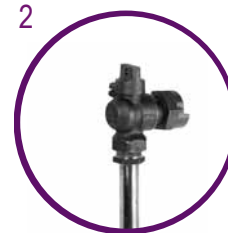

SETTER SIZE	CODE
5/8" Meter	1
5/8" x 3/4" Meter	2
3/4" Meter	3

HEIGHT (Centerline to Centerline)
15", 18", 21" and up (in 3" increments)

END CONNECTIONS	CODE
CB Compression	H
Campak	B
Gripjoint	GJ
Haystite	J
Kitec Connection	K
MIP	M
PEP (SIDR 7)	PE
PVC IPS	PJ
Copper Flare	C

INLET Options	CODE
No Valve	O
Key Angle Valve	AP
Reduced Port Valve	V
Full Port Valve	U

OUTLET Options	CODE
No Valve	O
Key Angle Valve	AP
Single Check	X
Single Check No Test Port	XN
Dual Check	Q
Dual Check No Test Port	QN
Reduced Port Ball Valve	V
Full Port Outlet	U

For proper part number please reference the Meter Setter part number build sheet on page 2

NO-LEAD METER SETTERS & ACCESSORIES

6060NL & 6065NL LINE SETTERS



6065NL-2B3D3-VQ
Plastic Idler bar included, not shown

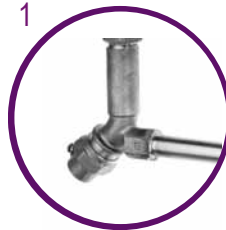
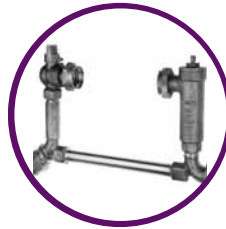

SETTER SIZE	CODE
5/8" Meter	1
5/8" x 3/4" Meter	2
3/4" Meter	3

HEIGHT (Centerline to Centerline)
Standard height 4" Centerline to Centerline

END CONNECTIONS	CODE
CB Compression	H
Campak	B
Gripjoint	GJ
Haystite	J
Kitec	K
FIP	F
MIP	M
PEP (SIDR 7)	PE
PVC IPS	PJ
Copper Flare	C
Dual Purpose	D

INLET Options	CODE
No Valve	O
Key Angle Valve	AP
Reduced Port Valve	V
Full Port Valve	U

OUTLET Options	CODE
No Valve	O
Key Angle Valve	AP
Single Check	X
Single Check No Test Port	XN
Dual Check	Q
Dual Check No Test Port	QN
Reduced Port Ball Valve	V
Full Port Outlet	U

For proper part number please reference the Meter Setter part number build sheet on page 2.

NO-LEAD METER SETTERS & ACCESSORIES

7010NL & 7011NL CELLAR SETTERS



7010NL-2H3H3
Plastic Idler bar included, not shown



SETTER SIZE	CODE
5/8" Meter	1
5/8" x 3/4" Meter	2
3/4" Meter	3

END CONNECTIONS	CODE
Dual Purpose	D
CB Compression	H
Campak	B
Gripjoint	GJ
Haystite	J
Kitec	K
FIP	F
MIP	M
PEP (SIDR 7)	PE
PVC (IPS)	PJ
Copper Flare	C
Solder	S
IP (Galvanized Pipe)	IP
3/4" Female, 1" Male Pipe Thread	FM



7011NL-2N1N1
Plastic Idler bar included



SETTER SIZE	CODE
5/8" Meter	1
5/8" x 3/4" Meter	2
1" Meter	4

INLET/OUTLET SIZE	CODE
5/8" Meter Thread	N1
5/8" x 3/4" Meter Thread	N2
1" Meter Thread	N4

For proper part number please reference the Meter Setter part number build sheet on page 2.

NO-LEAD METER SETTERS & ACCESSORIES

7020NL CORNER SETTER



7020NL-2S3S3
Plastic Idler bar included



SETTER SIZE	CODE
5/8" Meter	1
5/8" x 3/4" Meter	2
3/4" Meter	3
1" Meter	4

END CONNECTIONS	CODE
Dual Purpose	D
CB Compression	H
Campak	B
Gripjoint	GJ
Haystite	J
Kitec	K
FIP	F
MIP	M
PEP (SIDR 7)	PE
PVC (IPS)	PJ
Copper Flare	C
Solder	S
IP (Galvanized Pipe)	IP
Female Male	FM

7025NL CORNER SETTER WITH OPTIONAL VALVE

Integral ball angle valves and check are an option. Please contact factory.



Inlet



Outlet

INLET Options	CODE
No Valve	O
Key Angle Valve	AP
Reduced Port Valve	V
Full Port Valve	U

OUTLET Options	CODE
No Valve	O
Key Angle Valve	AP
Single Check	X
Single Check No Test Port	XN
Dual Check	Q
Dual Check No Test Port	QN
Reduced Port Ball Valve	V
Full Port Outlet	U

For proper part number please reference the Meter Setter part number build sheet on page 2.

NO-LEAD METER SETTERS & ACCESSORIES

METER NUT X MIP



PART NUMBER	INLET SIZE	OUTLET SIZE
405NL-T1M1	1/2"	1/2"
405NL-T3M3	3/4"	3/4"
405NL-T4M4	1"	1"

METER NUT X CB COMPRESSION



PART NUMBER	INLET SIZE	OUTLET SIZE
405NL-T3H3	3/4"	3/4"

METER NUT X CAMPAK COMPRESSION



PART NUMBER	INLET SIZE	OUTLET SIZE
405NL-T3B3	3/4"	3/4"

METER NUT X SOLDER



PART NUMBER	INLET SIZE	OUTLET SIZE
405NL-T3S3	3/4"	3/4"

EIGHT BEND METER COUPLING



PART NUMBER	INLET SIZE	OUTLET SIZE
406NL-T3M3	3/4"	3/4"
406NL-T4M4	1"	1"
406NL-T6M6	1 1/2"	1 1/2"

STRAIGHT METER COUPLING (ROUND BARREL)



PART NUMBER	INLET SIZE	OUTLET SIZE
412NL-T3M3	3/4"	3/4"
412NL-T3M32500	3/4"	3/4"
412NL-T4M4	1"	1"
412NL-T4M42500	1"	1"

NO-LEAD METER SETTERS & ACCESSORIES

METER TAIL NUT X MIP (OCTAGON BARREL)



PART NUMBER	INLET SIZE	OUTLET SIZE
417NL-T1M1	1/2"	1/2"
417NL-T1M3	1/2"	3/4"
417NL-T3M1	3/4"	1/2"
417NL-T3M3	3/4"	3/4"
417NL-T3M32000	3/4"	3/4"
417NL-T3M32250	3/4"	3/4"
417NL-T3M33000	3/4"	3/4"
417NL-T3M312000	3/4"	3/4"
417NL-T4M4	1"	1"
417NL-T4M41812	1"	1"
417NL-T6M6	1 1/2"	1 1/2"
417NL-T7M7	2"	2"

METER TAIL NUT X SOLDER



PART NUMBER	INLET SIZE	OUTLET SIZE
417NL-T1S1	1/2"	1/2"
417NL-T1S3	1/2"	3/4"
417NL-T3S1	3/4"	1/2"
417NL-T3S3	3/4"	3/4"
417NL-T4S4	1"	1"

METER TAIL NUT X CAMPAK



PART NUMBER	INLET SIZE	OUTLET SIZE
417NL-T1B1	1/2"	1/2"
417NL-T1B3	1/2"	3/4"
417NL-T3B3	3/4"	3/4"
417NL-T3B4	3/4"	1"
417NL-T4B4	1"	1"

METER NUT X CB COMPRESSION



PART NUMBER	INLET SIZE	OUTLET SIZE
417NL-T1H3	1/2"	3/4"
417NL-T3H3	3/4"	3/4"
417NL-T3H4	3/4"	1"
417NL-T4H4	1"	1"

NO-LEAD METER SETTERS & ACCESSORIES

METER NUT X IP (GALVANIZED) PIPE



PART NUMBER	INLET SIZE	OUTLET SIZE
417NL-T1IP1	1/2"	1/2"
417NL-T1IP3	1/2"	3/4"
417NL-T3IP3	3/4"	3/4"
417NL-T4IP4	1"	1"

METER NUT X FIP



PART NUMBER	INLET SIZE	OUTLET SIZE
417NL-T3F3	3/4"	3/4"
417NL-T3F4	3/4"	1"

METER NUT X KITEC



PART NUMBER	INLET SIZE	OUTLET SIZE
417NL-T3K3	3/4"	3/4"

PEX METER COUPLING



PART NUMBER	INLET SIZE	OUTLET SIZE
417NL-T1W3	1/2"	3/4"
417NL-T3W3	3/4"	3/4"

FIP X MIP METER COUPLING



PART NUMBER	INLET SIZE	OUTLET SIZE
416NL-F6M6	1 1/2"	1 1/2"
416NL-F7M7	2"	2"

NO-LEAD METER SETTERS & ACCESSORIES

METER SIZING BUSHING



PART NUMBER	INLET SIZE	OUTLET SIZE
440NL-N3R2	5/8"	5/8" X 3/4"
440NL-N3N2XL (LONG)	5/8"	5/8" X 3/4"
440NL-N3R2	5/8"	5/8" X 3/4"
440NL-N4R2	1"	5/8" X 3/4"

METER BUSHINGS - METER THREAD X MIP (REGULAR ADAPTOR FOR TANDEM SETTERS)



PART NUMBER	INLET SIZE	OUTLET SIZE
440NL-N3M3	3/4"	3/4"
440NL-N4M4	1"	1"

RUBBER METER GASKETS



PART NUMBER	SIZE
41-1	1/2"
41-3	3/4"
41-4	1"
41-6	1 1/2"
41-7	2"

FLANGED RUBBER METER GASKETS



PART NUMBER	SIZE
42-6	1 1/2"
42-7	2"

FIBER METER GASKETS



PART NUMBER	SIZE
45-1	5/8"
45-3	5/8" X 3/4"
45-4	1"

BOLT KITS FOR METER FLANGES (ZINC PLATED) (4 PER KIT)



PART NUMBER	SIZE
42-2	1 1/2"
42-3	2"

NO-LEAD METER SETTERS & ACCESSORIES

BOLT KITS FOR METER FLANGES (STAINLESS STEEL) (4 PER KIT)



PART NUMBER	SIZE
42-0	1 1/2"
42-1	2"

PLASTIC IDLER BARS



PART NUMBER	METER SIZE
450-1	1/2"
450-2	1/2"
450-3	3/4"
450-4	1"

COPPER IDLER BARS



PART NUMBER	METER SIZE
450NL-6	1 1/2"
450NL-7	2"

BRASS METER FLANGE X FIP KIT



PART NUMBER	INLET SIZE	OUTLET SIZE
421NL-6	1 1/2"	1 1/2"
421NL-7	2"	2"

CAST IRON METER FLANGE X FIP KIT



PART NUMBER	INLET SIZE	OUTLET SIZE
422-6	1 1/2"	1 1/2"
422-7	2"	2"

METER FLANGE X SOLDER KIT



PART NUMBER	INLET SIZE	OUTLET SIZE
423NL-6	1 1/2"	1 1/2"
423NL-7	2"	2"

NO-LEAD METER SETTERS & ACCESSORIES

BRASS METER FLANGE X MIP KIT



PART NUMBER	INLET SIZE	OUTLET SIZE
424NL-6	1 1/2"	1 1/2"
424NL-7	2"	2"

BRASS METER FLANGE X FIP (FLANGES ONLY)



PART NUMBER	INLET SIZE	OUTLET SIZE
5030295NL	1 1/2"	1 1/2"
5030390NL	2"	2"

BRASS METER FLANGES X FIP KIT (WITH SS BOLTS)



PART NUMBER	INLET SIZE	OUTLET SIZE
421NL-6SS	1 1/2"	1 1/2"
421NL-7SS	2"	2"

CAST IRON METER FLANGE X FIP KIT (WITH SS BOLTS)



PART NUMBER	INLET SIZE	OUTLET SIZE
422-6SS	1 1/2"	1 1/2"
422-7SS	2"	2"

METER FLANGE X SOLDER KIT (WITH SS BOLTS)



PART NUMBER	INLET SIZE	OUTLET SIZE
423NL-6SS	1 1/2"	1 1/2"
423NL-7SS	2"	2"

METER FLANGE X MIP KIT (WITH SS BOLTS)



PART NUMBER	INLET SIZE	OUTLET SIZE
424NL-6SS	1 1/2"	1 1/2"
424NL-7SS	2"	2"

NO-LEAD METER SETTERS & ACCESSORIES

SINGLE CHECK VALVE - ANGLE STYLE



PART NUMBER	METER SIZE	OUTLET SIZE
590NL-T3F3	5/8" X 3/4" 3/4"	3/4"
590NL-T4F4	1"	1"
590NL-T3H3	5/8" X 3/4" 3/4"	3/4"

DUAL CHECK VALVE - ANGLE STYLE



PART NUMBER	METER SIZE	OUTLET SIZE
500NL-T1F1	5/8"	3/4"
500NL-T3F3	5/8" X 3/4" 3/4"	3/4"
500NL-T4F4	1"	1"
500NL-MF6F6	1 1/2"	1 1/2"
500NL-MF7F7	2"	2"

METER NUT X CB COMPRESSION



PART NUMBER	METER SIZE	OUTLET SIZE
500NL-T3H3	5/8" X 3/4" 3/4"	3/4"
500NL-T4H4	1"	1"

DUAL CHECK VALVE - ACCESSIBLE



PART NUMBER	METER SIZE	OUTLET SIZE
510NL-T3F3	5/8" X 3/4" 3/4"	3/4"

INLINE NON ACCESSIBLE



PART NUMBER	METER SIZE	OUTLET SIZE
520NL-T3F3	5/8" X 3/4" 3/4"	3/4"
520NL-F3F3	5/8" X 3/4" 3/4"	3/4"

DUAL CHECK VALVE REPAIR KITS



PART NUMBER	METER SIZE
50-3	3/4"
50-4	1"
50-7	1 1/2" & 2"

CAMBRIDGE BRASS LIFETIME WARRANTY

Cambridge Brass, Inc., 140 Orion Place, Cambridge, Ontario warrants to the installing purchaser that products manufactured by Cambridge Brass are free from defects in material and/or workmanship for the lifetime of the product.*

Effective with products produced March 1st, 2005 or thereafter Cambridge Brass will, at its option, repair or replace any part which proves to be defective in material and/or workmanship during the warranty period under approved installation, water and service conditions and use.

If Cambridge Brass concludes that the returned part was manufactured by Cambridge Brass and is, in fact, defective, then Cambridge brass will honor the warranty stated herein. LABOUR CHARGES AND/OR DAMAGED INCURRED IN INSTALLATION, REPAIR OR REPLACEMENT AS WELL AS CONSEQUENTIAL, SPECIAL, INDIRECT OR PUNITIVE DAMAGES CONNECTED THEREWITH ARE EXCLUDED AND WILL NOT BE PAID BY CAMBRIDGE BRASS.

This warranty is void in the event of any damage to the product due to uses other than those for which the product has been designed & promoted, abuse, neglect, accident, improper installation, any use other than the instructions furnished by Cambridge Brass or use of replacement parts other than genuine Cambridge parts.

The Lifetime Warranty terms described herein do not apply to plug (key) style valves or to any moving plastic parts such as check valves.



Cambridge Brass does warrant these parts for 5 years per the other terms of this Lifetime warranty.

This is the complete and exclusive warranty made by Cambridge Brass. Cambridge Brass does not make any other warranty of any kind, including any implied warranties.

*assumes a 40 year product life span.



CAMBRIDGE BRASS INC.
WATERWORKS BRASS MANUFACTURERS

140 Orion Place, Cambridge, Ontario, N1R 5V1, Canada
www.cambridgebrass.com
Phone: 519-621-5520 Canada Toll Free: 1-800-265-6638
U.S. Toll Free: 1-800-724-3906 Fax: 519-621-8038

© 2009 Cambridge Brass Inc. JUNE2012 CAMB2012